



# User Manual

Applicable to Part No(s): HGAXPXGXHXVX



## Revision History

Revision	Comment	Author	Date
0.1	Creation of document – Draft	Joe Holdsworth	06-12-2024
1	Release of document	Joe Holdsworth	13-12-2024

# User Manual

## Contents

System Overview .....	5
Sensor Options/Variants .....	5
Sensor CAN Overview .....	5
Unit Specification .....	6
Sensor .....	6
Environmental.....	6
Mechanical.....	7
Electrical .....	7
Connection.....	7
Electrical.....	8
Mating Connector .....	8
Crimps .....	8
CAN Termination .....	8
Wiring Example .....	9
Mechanical .....	10
Mounting.....	10
Dimensions .....	10
Suggested Installation .....	11
Quick Start Guide .....	12
Step 1: Power Up Unit .....	12
Step 2: Connect CAN Tool.....	12
Step 3: Enter Setup Mode.....	14
Step 4: Change a Setting.....	14
Step 5: Save Setup .....	14
Step 6: Reset to Factory Defaults.....	14
Step 7: Calibrate the Sensors .....	14
Power Modes .....	15
CAN Wake Features .....	15
Parameters Supporting Wake Up.....	15
Wake Flag Types.....	15
Setting a Threshold, Wake & Function Pin.....	15
Threshold Types .....	15
Wake Flag.....	15
Function Pin .....	15
Gas Threshold Detection Notes* .....	16
Sensor Maintenance .....	16
CAN Message Format.....	17
CAN Message Summary.....	17

## User Manual

HG_Config (0x30A[default]) .....	18
Configuration CAN Message .....	18
HG_Config CAN Message Types .....	19
Heartbeat – HG_Config Multiplexor x00_Heartbeat .....	23
Overview .....	23
Default settings .....	23
Format .....	23
Layout .....	23
Enter Setup Command (0x01_Cmd_Enter_Setup) .....	24
Save Setup Command (0x02_Cmd_Save_Setup) .....	24
Cancel Setup Command (0x03_Cmd_Cancel_Setup) .....	24
Reset Unit To Factory Default Settings (0x04_Cmd_Rst_to_Factory_Defaults) .....	25
Reboot Device (0x05_Cmd_Reboot_Device) .....	25
Get Unit Information and Errors (0x06_Cmd_Get_Info_and_Errors) .....	25
Reset Unit Information and Errors (0x07_Cmd_Rst_Info_and_Errors) .....	26
Get Unit ID (0x08_Cmd_Get_Unit_ID) .....	26
Set Unit ID (0x09_Cmd_Set_Unit_ID) .....	26
Received Unit ID (0x0A_Resp_Unit_ID) .....	27
Get CAN Bus Speed (0x0B_Cmd_Get_CAN_Bus_Speed) .....	27
Set CAN Bus Speed (0x0C_Cmd_Set_CAN_Bus_Speed) .....	27
Received CAN Bus Speed (0x0D_Resp_CAN_Bus_Speed) .....	28
Get CAN start address (0x0E_Cmd_Get_CAN_Start_Address) .....	28
Set CAN start address (0x0F_Cmd_Set_CAN_Start_Address) .....	28
Received CAN Start Address (0x10_Resp_CAN_Start_Address) .....	29
Get Unit Mode (0x11_Cmd_Get_Sleep_Mode) .....	29
Set Unit Mode (0x12_Cmd_Set_Unit_Mode) .....	29
Sleep Mode Response (0x13_Resp_Sleep_Mode) .....	30
Other Configuration CAN Messages .....	30
HG_H2 (0x30B [default]) – Hydrogen .....	31
Overview .....	31
Default settings .....	31
Format .....	31
Layout .....	31
HG_Moisture_and_Temp (0x30C [default]) .....	33
Overview .....	33
Default settings .....	33
Format .....	33
Layout .....	33
HG_Pressure (0x30D [default]) .....	34

## User Manual

Overview.....	34
Default settings.....	34
Format.....	34
Layout.....	34
HG_Accelerometer (0x30F [default]).....	35
Overview.....	35
Default settings.....	35
Format.....	35
Layout.....	35
List of Tables.....	36
List of Figures.....	37
Appendix A – Example CAN Message Workflow to Change a Setting.....	38
Appendix B – Example CAN Message to Change Message Update Rate.....	39
Appendix C – Example Functionality Test Method.....	42

## User Manual

# System Overview

H Guard is a CAN based sensor that can measure absolute pressure, air temperature, H<sub>2</sub> (Hydrogen), absolute air water content, relative humidity, dew point temperature and 3 axis acceleration.

The configurable CAN bus speed and address along with the supplied CAN DBC file allows easy integration into almost any system to detect hydrogen leakage or formation. The unit features a low power mode in which it monitors the environment but does not transmit on CAN unless a threshold is reached at which point it reverts to normal mode. It also features a low side drive function pin capable of 500mA that can be triggered if a programmable threshold is reached.

The 5-pin automotive rated Molex Nano-Fit Power connector, small size and mass allows easy interface into most vehicles and energy storage systems. The unit is developed in accordance with ISO26262 and has been tested to automotive standards which include: ISO7637-2 2011, ISO 17650- 2 2012 and ISO 17650-4 2010. ATEX approval is pending.

## Sensor Options/Variants

This manual is applicable to all versions of H Guard.

### Part Number Ordering Details

Default Part Number: **HGA0P1G1H1V1**

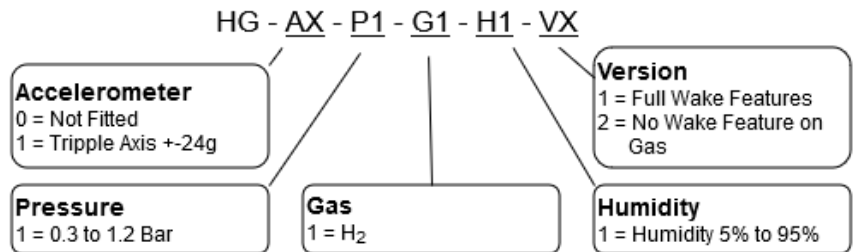

## Sensor CAN Overview

Can Messages Identifier: 11bit

Data Format (all messages): Intel.

Termination: Unterminated (no 120 Ohm termination resistor)

Default CAN Bus Speed: 500kbps

Default CAN Start Address (decimal): 0x30A (778)

# User Manual

## Unit Specification

### Sensor

<b>Pressure Sensor</b>	Range	0.3 to 1.2	Bar
	Resolution	0.0001	Bar
	Accuracy (0.3 to 1.1 Bar)	0.0005	Bar
	Max Update Rate	50	Hz
<b>Air Temperature [1]</b>	Range	-40 to 125	°C
	Resolution	1	°C
	Accuracy	+1 (+-2 at 24VDC)	°C
	Max Update Rate	5	Hz
<b>Hydrogen</b>	Range	0 to 20% Vol. concentration	%
	Resolution	0.002	%
	Accuracy	0.4 vol% + 10% m.v.	%
	Max Update Rate	1 (Response Time: $\tau(63) < 1s$ )	Hz
<b>Absolute Humidity [2]</b>	Range	0 - 35000	mg/m <sup>3</sup>
	Resolution	70	mg/m <sup>3</sup>
	Accuracy (Worse Case)	5	%FSS
	Max Update Rate	5	Hz
<b>Dew Point</b>	Range	0-100	°C
	Resolution	0.5	°C
	Accuracy (Worse Case)	+3	°C
	Max Update Rate	5	Hz
<b>Relative Humidity [2]</b>	Range	0-100	%
	Resolution	0.5	%
	Accuracy (Worse Case)	3	%
	Max Update Rate	5	Hz
<b>Accelerometer [3]</b>	Range	-24 to +24	g
	Resolution	0.01	g
	Accuracy (Worse Case)	0.1	g
	Max Update Rate	200	Hz

**TABLE 1 SENSOR PERFORMANCE**

### Environmental

<b>Environment</b>	Operating temperature	-40 to +85	°C
--------------------	-----------------------	------------	----

**TABLE 2 ENVIRONMENTAL PERFORMANCE**

<b>Mass</b>		15	grams
<b>Dimensions</b>	Height x Width x Length	11.5 x 55 x 63	mm

**TABLE 3 MECHANICAL PERFORMANCE**

Electrical

<b>CAN</b>	Baud Rates [4]	1000, 500, 250, 125	kbps
	Address Range [5]	1 (0x01) to 2042 (0x7FA). Default = 0x30A	decimal (Hex)

<b>Power</b>	Voltage Range	9 to 32 [8]	VDC
	Current (low power)	24mA (0.75mA) (H2)	mA @ 12V
<b>Power – LSD Wake Pin [7]</b>	Voltage Range [6]	9 to 32	V
	Current	500	mA
	Type	Low Side Drive	NA

**TABLE 4 ELECTRICAL PERFORMANCE**

Connection

<b>Connector</b>	
MF (family)	Molex (Nano Fit)
On Unit	1053131205
Mating	1053071205
Crimp	1053001200
<b>Pin Outs</b>	
Pin No.	Function
1	Ground
2	Supply Voltage
3	CAN Low
4	CAN High
5	SW Configured Function

**TABLE 5 CONNECTION INFORMATION**

- [1] Air Temperature accuracy is dependent on installation, heat from the sensor itself can affect this
- [2] Humidity accuracy valid from 0 to 80 deg C IC temperature and 5 to 95% RH
- [3] Not normally fitted, only on variant with accelerometer option selected
- [4] The default settings are 500kbps and start address 778 (0x30A), the unit has no CAN termination
- [5] The unit uses up to 5 CAN addresses which are in consecutive order from address that the unit is set to
- [6] The function pin is protected to transients up to 40VDC but is not current limited, please ensure load is not above 500mA
- [7] The function of this pin is assigned when configuring the unit please refer to the manual
- [8] Only the range of 9-16V has been tested to ISO standards. Outside of this range is not tested to ISO standards.

User Manual  
Electrical

Mating Connector

Manufacturer: Molex

Family: Nano-Fit

Part No.: 1053071205

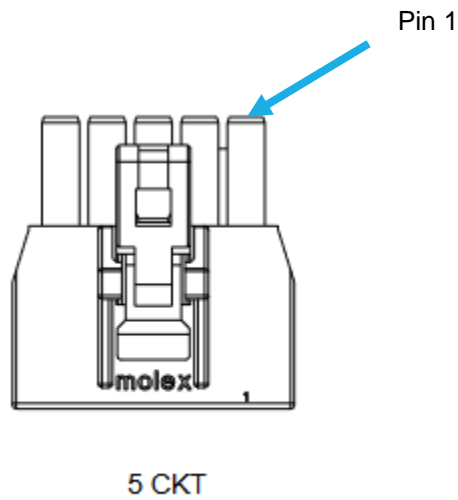

FIGURE 1 MATING CONNECTOR - PIN 1 IS RIGHT HAND SIDE (TOP-DOWN VIEW)

Crimps

Crimp Part No. : 205300-XXXX

Crimp Tool Part No.: 638276000

Nano-Fit Terminal Position Assurance (TPA) Retainer Part No.: 105325-XXXX

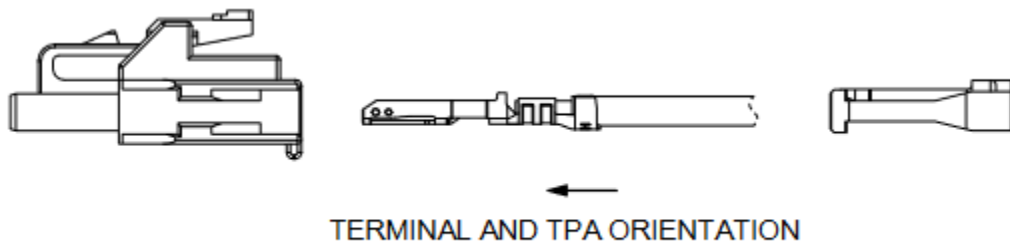

FIGURE 2 CONNECTOR CRIMP DETAILS

CAN Termination

The unit does not have a termination resistor.

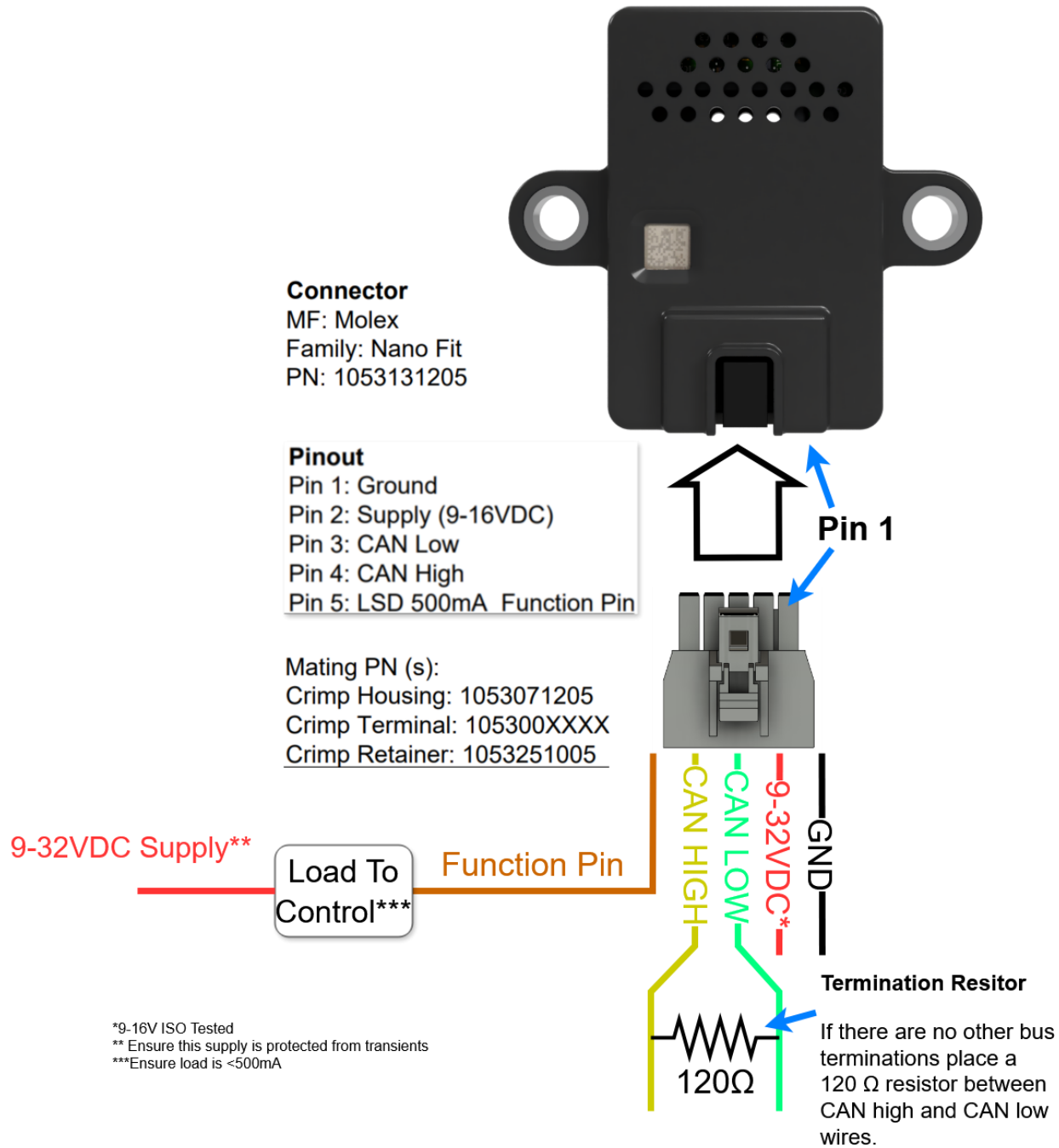

FIGURE 3 WIRING EXAMPLE

### Mounting

Mount using 2 x M5 bolts with torque setting 4Nm for dry (3Nm Lube).

Mount near breather port (if possible and fitted) and/or where gases are expected to travel or collect. Mount so moisture does not pool around sensor.

### Dimensions

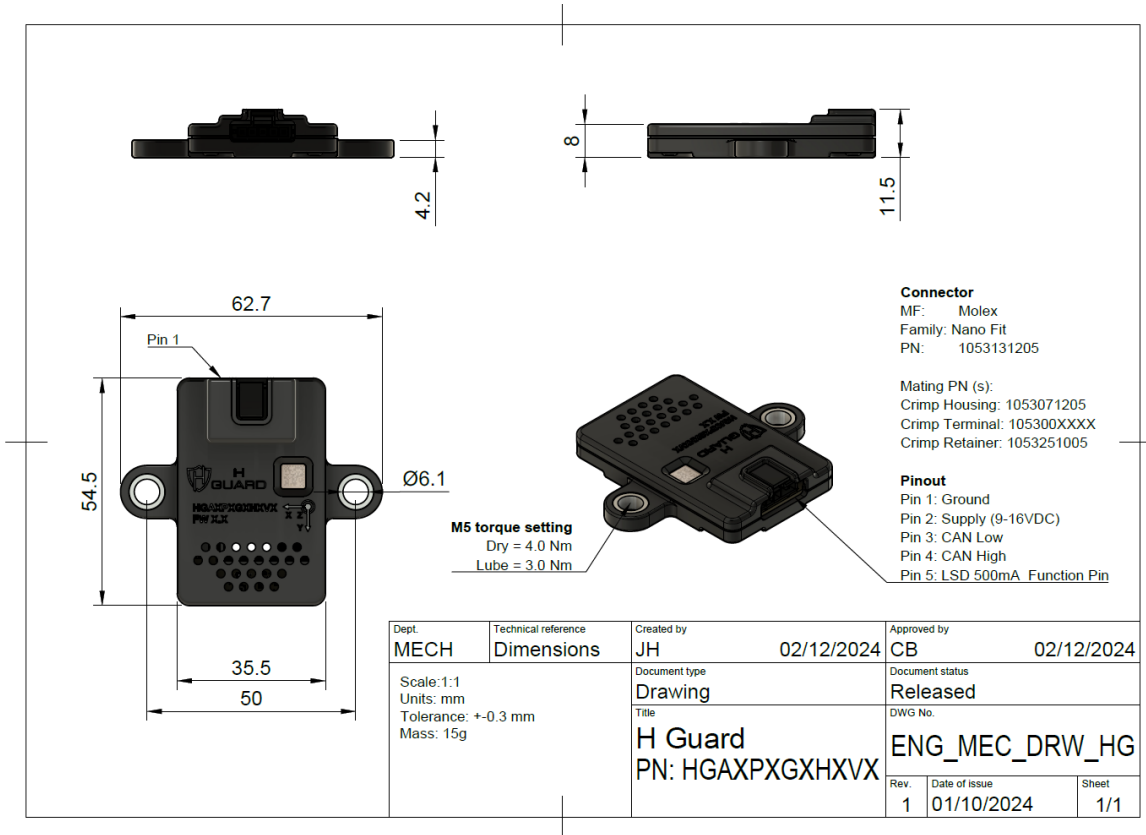

FIGURE 4 SENSOR DIMENSIONS

## Suggested Installation

Install where hydrogen is expected to collect. If it is the accelerometer variant ideally the sensor is aligned with the axis of the vehicle to ease processing of data.

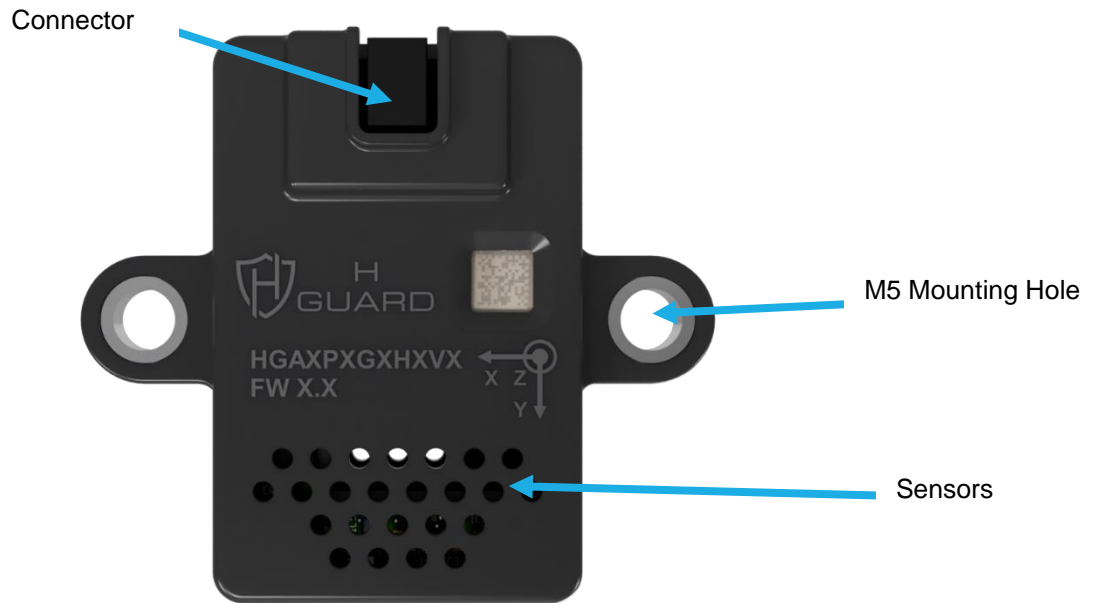

FIGURE 5 EXTERNAL FEATURES

## Quick Start Guide

This section gives a quick overview of how to change settings on the device.

To see Default settings the unit ships with, please refer to the CAN Message Summary section.

### Step 1: Power Up Unit

Make sure power and CAN is connected to the device using the pin outs as previously described in table 5.

If the CAN bus is unterminated or the unit is the only node on the CAN bus, please place a 120Ohm resistor between CAN high and CAN low lines.

Apply 9-16VDC to the unit with a supply capable of 50mA.

### Step 2: Connect CAN Tool

1. Ideally use a CAN tool such as PCAN or CANalyser.
2. Make sure the CAN bus connection settings in the tool match the settings specified in the unit's default settings section e.g. 11bit address and 500kbps CAN bus speed.
3. Import the unit's DBC or symbols file into the CAN tool.
4. Start the CAN interface on the computer.
5. If connection is successful, the CAN Heartbeat message will appear from the unit. If not, then check the following.
  - a. The unit has power.
  - b. The CAN connection settings are correct.
  - c. The CAN bus is terminated correctly.
  - d. The CAN high and low lines are the correct way round.

Below shows the default message output from the unit. **Please take note of the Unique ID value and the Key value.** these will be required when entering setup mode or saving any changes to the setup. Please be aware that the key value changes each time a valid enter setup command has been received.

Bus	CAN-ID (hex)	Length	Symbol	Data	Cycle Time	
Receive	1	30A	8	HG_Config.x00_Heartbeat	<ul style="list-style-type: none"> <li>Unique_ID = 16591788</li> <li>Key = 29773</li> <li>Unit_ID = 0</li> <li>Fault_Gas = OK</li> <li>Fault_Humidity = OK</li> <li>Mode = Normal Mode</li> <li>Fault_EEPROM = OK</li> <li>Fault_Pressure = OK</li> <li>Wake_Flag = Off</li> <li>Fault_Accelerometer = OK</li> </ul>	1000.0
	1	30B	8	HG_H2	<ul style="list-style-type: none"> <li>H2_Calculated_Perc_Vol = 0.000 %</li> <li>Fault_Gas_Sensor_Error_Code = OK</li> <li>Wake_Flag_H2 = Off</li> <li>Fault_Gas_Sensor_Error_Detail = NonemptyFrameError</li> <li>H2_Memory_Error = 0</li> <li>H2_Self_Test_Error = 0</li> <li>H2_VDD_Out_Of_Range = 0</li> <li>H2_Temp_Comp_Out_Of_Range = 0</li> <li>H2_Internal_Temp_DegC = 17.8 deg C</li> </ul>	999.9
	1	30C	8	HG_Moisture_and_Temp	<ul style="list-style-type: none"> <li>Air_Temperature = 15 deg C</li> <li>Absolute_Humidity = 5517 mg/m^3</li> <li>Dew_Point_Temperature = 2.5 deg C</li> <li>Relative_Humidity = 42.5 %</li> <li>Fault_Humidity_Chk_Sum = OK</li> <li>Fault_Humidity_Cmd = OK</li> <li>Humidity_Rst_Detected = False</li> <li>Fault_Humidity_Sensor_Comms = OK</li> <li>Wake_Flag_RH = Off</li> <li>Wake_Flag_Dew_Point = Off</li> <li>Wake_Flag_Temperature = Off</li> </ul>	199.9
	1	30D	5	HG_Pressure	<ul style="list-style-type: none"> <li>Absolute_Pressure = 1039.046 mBar</li> <li>Fault_Pressure_Last_Update = OK</li> <li>Fault_Pressure_Sensor_Comms = OK</li> <li>Wake_Flag_Pressure = Off</li> </ul>	20.0
	1	30F	8	HG_Accelerometer	<ul style="list-style-type: none"> <li>Xg = 0.96 g</li> <li>Yg = 0.19 g</li> <li>Fault_Accelerometer_Init = OK</li> <li>Fault_Accelerometer_Read = OK</li> <li>Wake_Accelerometer = 0</li> <li>Xg_Over_g_Wrn = 0</li> <li>Xg_Under_g_Wrn = 0</li> <li>Yg_Over_g_Wrn = 0</li> <li>Yg_Under_g_Wrn = 0</li> <li>Zg_Over_g_Wrn = 0</li> <li>Zg_Under_g_Wrn = 0</li> <li>Fault_Accelerometer_Self_Test = OK</li> <li>Zg = 0.37 g</li> </ul>	8.3

FIGURE 6 DEFAULT CAN MESSAGE OUTPUT

## User Manual

### Step 3: Enter Setup Mode

1. The Heartbeat message should give:
  - a. A Unique ID value.
  - b. A Key value.
  - c. The unit ID sending the heartbeat message.
  - d. The run mode - this should be 'Normal' if the unit has just powered up.
  - e. Unit fault information
  - f. Wake flag if a threshold has been exceeded, by default the wake feature is turned off to begin with.
2. Take note of both the Unique ID value and the Key value.
3. Create a Setup Mode message as defined in the CAN DBC, this message is multiplexed with the units heartbeat message.
4. Populate the Unique ID and Key field in the setup message with the values noted from the heartbeat message.
5. Send the 'Enter Setup Mode' Command to the unit -this should only be sent once.
6. The next Heartbeat message received from the unit should have the run mode changed to 'Setup mode'. If does not happen check your unique ID and Key value match those in the heartbeat message.
7. Once in setup mode the unit can be configured.
8. Any changes that have been made will not be applied until a 'Save Setup' command has been sent.
9. To cancel any changes prior to the 'Save Setup' command, send the 'Cancel Setup' command or power cycle the device.

### Step 4: Change a Setting

To change a setting the unit has to be in setup mode, once in setup mode send the correct CAN message to the unit, for example to change the CAN start Address send `x0F_Cmd_Set_CAN_Start_Address` making sure the unit unique ID field is set correctly and the CAN address field is set correctly. Once the message is sent a confirmation `x10_Resp_CAN_Start_Address` message will be sent back from the sensor confirming the change.

### Step 5: Save Setup

To apply any configuration changes, send the 'Save Setup' command with the Unique ID and Key value field populated with the current value in the heartbeat message.

Note: The Key value changes each time a successful message has been received, any changes to the unit will not be applied until a 'Save Setup' command has been sent.

### Step 6: Reset to Factory Defaults

To restore factory settings, send a reset to factory settings CAN message to the unit.

### Step 7: Calibrate the Sensors

The unit comes factory calibrated. It is still possible to alter the baseline reading for the Hydrogen sensor, this can be done through the CAN interface once in setup mode.

## Power Modes

There are 2 power modes which can be set by sending the **x12\_Cmd\_Set\_Low\_Power\_Mode** command to the unit, unlike every other setting on the unit, the unit does **not** need to be in setup mode for these commands to work. On power cycle the unit will always default to normal mode.

1. **Normal** – the unit will transmit data at each sensors set update rate.
2. **Low power** – the unit turns stops transmitting CAN data until it is commanded back to Normal mode, power cycled or if a threshold has been configured and is detected.

## CAN Wake Features

The unit supports wake up from certain parameters. By default, wake up is turned off, to configure wakeup the unit must be in setup mode which is accessed via a CAN command.

### Parameters Supporting Wake Up

1. Pressure
2. Relative Humidity
3. Dew Point
4. Air Temperature
5. Accelerometer
6. H<sub>2</sub> % By Volume\*

\*excluding H Guard with product number V2.

Once a threshold has been detected and if the function is enabled, the relevant wake flag will be set in the CAN messages. If the unit is in low power mode it will wake up, if the wake IO is turned on for that parameter the function pin will trigger.

### Wake Flag Types

1. Off – not enabled
2. On – threshold flag and if set IO will trigger if threshold is reached, flag and IO will clear once value falls below the threshold.
3. Latching - threshold flag and if set IO will trigger if threshold is reached and will not clear unless a CAN command is sent to the unit. The flag will also be set between power cycles.

### Setting a Threshold, Wake & Function Pin

There are several options when setting threshold detection for each parameter, the first thing is to establish the threshold values, these do not all have to be populated as they are enabled or disabled via flags.

#### Threshold Types

1. Maximum value above which wake flag will be set and unit will wake up if in low power mode
2. Minimum value below which wake flag will be set and unit will wake up if in low power mode
3. Rate of change between readings above which wake flag will be set (the rate of change can be negative as well as positive) and unit will wake up if in low power mode.

#### Wake Flag

A wake flag setting is available for each threshold type (min, max, rate of change) and can be set to off, on, or latching.

#### Function Pin

The function pin can be set to on or off and if on will trigger if any of the wake flags are on the pin is a low side drive capable of 500mA, it is not current limited so please ensure that the load is not more that 500mA, maximum withstand voltage is 40VDC.

## User Manual

### Gas Threshold Detection Notes\*

The function pin and wake up for the Hydrogen sensor is available immediately after power up.

\*excluding H Guard with product number V2.

## Sensor Maintenance

The H<sub>2</sub> sensor comes factory calibrated but may need periodic recalibration. Other sensors on the unit should not require recalibration.

The rebase can be done by sending a CAN command to the unit. The command x78\_Cmd\_Set\_User\_H2\_Baseline will set the sensors base line to whatever the current reading is, please make sure that the environment is free of Hydrogen before doing this.

The user can also specify a baseline % by sending the command x79\_Cmd\_Set\_Curr\_H2\_Baseline.

Please note once a new baseline is set a factory reset will **not** restore the original value.

# CAN Message Format

Can Messages Identifier: 11bit

Data Format (all messages): Intel.

Termination: Unterminated (no 120 Ohm termination resistor)

Default CAN Bus Speed: 500kbps

Default CAN Start Address (decimal): 0x30A (778)

## CAN Message Summary

The unit uses up to 5 CAN message ID's.

Default CAN Address Hex (Decimal)	Message Name	Description	Default Frequency Sent from Unit (milliseconds)	Frequency To Unit (milliseconds)	Notes
0x30A (778)	HG_Config	Used to send and receive configuration settings and values from the unit. This address is also used by the unit to send its heartbeat message. Functionality is selected by changing the multiplexor value field in this message	1000ms (Heartbeat)	User dependant	
0x30B (779) [1 + Config Address]	HG_H2	H2 % by volume, sensor status	1000ms	NOT APPLICABLE	
0x30C (780) [2 + Config Address]	HG_Water_and_Temp	Absolute humidity, dew point, relative humidity output, air temp and sensor status	200ms	NOT APPLICABLE	
0x30D (771) [3 + Config Address]	HG_Pressure	Absolute pressure output and sensor status	20ms	NOT APPLICABLE	
0x30F (771) [3 + Config Address]	HG_Accelerometer	3 axis accelerometer reading and status	10ms	NOT APPLICABLE	

TABLE 6 CAN MESSAGE OUTPUT SUMMARY

## HG\_Config (0x30A[default])

### Configuration CAN Message

CAN Address: Please see unit's default CAN start address details in the CAN Message Format section.

Overview: This CAN message is used to send configuration commands to the unit and is also used to receive configuration data from the unit and a heartbeat message with an overview of the unit's status.

Format: Intel

Layout:

Byte(s)	Data Type	Name	Description
0 – 2	Unsigned 24 bit integer	Unique ID	The unit's unique identifier, enabling the user to distinguish between multiple units on the same CAN bus.
3	Unsigned 8 bit integer	Message Type	This field is a multiplexor used to identify the message type.  Mux values 0x00(0) to 0x29 (41) are common across all units. Please refer to the common CAN message section.  Mux values 0x30(42) to 0xFF (255) change depending on sensor type. Please refer to the unit specific CAN message section.
4-7 (length can vary depending on message type)	Variable	Variable	The remaining 4 bytes are used depending on the command or data being sent back from the unit, not all 8 bytes are populated in every message.

TABLE 7 CAN CONFIGURATION MESSAGE

## User Manual

### HG\_Config CAN Message Types

Overview: These are the multiplexor message IDs that populate byte 3 of the configuration CAN message. The multiplexor messages highlighted in grey cells only work if the unit is in Setup mode.

Hex (Decimal) Value	Purpose	CAN DBC Name	Description
0x00 (0)	Heartbeat	x00_Heartbeat	Message that gets sent out to indicate the unit is alive on the CAN bus, it's status and what the unit type is.
0x01 (1)	Enter Setup	x01_Cmd_Enter_Setup	Command sent to unit to put it into setup mode, <b>the unit needs to be in setup mode to make any configuration changes to the unit.</b>
0x02 (2)	Save Setup	x02_Cmd_Save_Setup	Command to save any configuration changes that have been made whilst the unit was in Setup mode. <b>To apply any configuration changes this needs to be sent!</b> The unit reboots after this message is received.
0x03 (3)	Cancel Setup	x03_Cmd_Cancel_Setup	Command to cancel any changes that have been made in the current Setup mode.
0x04 (4)	Reset Unit to Factory Defaults	x04_Cmd_Rst_to_Factory_Defaults	Resets the unit to factory defaults.
0x05 (5)	Power cycle device	x05_Cmd_Reboot_Device	Any settings not saved will be lost
0x06 (6)	Get Unit Statistics	x06_Cmd_Get_Info_and_Errors	Request that the unit sends its statistics
0x07 (7)	Reset Unit Statistics	x07_Cmd_Rst_Info_and_Errors	Request that the unit's statistics be reset
0x08 (8)	Get Unit ID	x08_Cmd_Get_Unit_ID	The unit replies with the current ID that has been set.
0x09 (9)	Set Unit ID	x09_Cmd_Set_Unit_ID	Sets the ID of the unit so if there is more than 1 unit on the CAN bus they can be distinguished.
0x0A (10)	Unit ID response	x0A_Resp_Unit_ID	The unit's reply to a request for its unit ID (this message is only used by the unit and should not be sent to the unit)
0x0B (11)	Get the CAN bus speed	x0B_Cmd_Get_CAN_Bus_Speed	Request the unit to send the current CAN bus speed. [1]
0x0C (12)	Set the CAN bus speed	x0C_Cmd_Set_CAN_Bus_Speed	Set the unit's CAN bus speed.
0x0D (13)	CAN bus speed response	x0D_Resp_CAN_Bus_Speed	The unit's response message indicating the current CAN bus speed.[1]
0x0E (14)	Get the CAN start address	x0E_Cmd_Get_CAN_Start_Address	Request the unit to send the current CAN start address. [1]
0x0F (15)	Set the CAN start address	x0F_Cmd_Set_CAN_Start_Address	Set the unit's CAN bus start address.
0x10 (16)	CAN bus start address response	x10_Resp_CAN_Start_Address	The unit's response message indicating the current CAN bus start address for the unit.[1]

## User Manual

Hex (Decimal) Value	Purpose	CAN DBC Name	Description
0x11 (17)	Get Low Power mode	x11_Cmd_Get_Unit_Mode	Gets the current unit mode
0x12 (18)	Set Low Power mode	x12_Cmd_Set_Unit_Mode	Sets the unit mode
0x13 (19)	Low Power mode response	x13_Resp_Unit_Mode	The unit's mode
0x17 (20)	Firmware Version	x17_Resp_Firmware_Version	The firmware version on the unit
0x18 (21)	Power Cycle Count	x18_Resp_Pwr_Cycle_Cnt	The number of times the unit has been turned on
0x1A (26)	EEPROM Write Count	x1A_Resp_EEPROM_Write_Cnt	The number of times EEPROM has been written to
0x1B (27)	MCU Statistics	x1B_Resp_MCU_Stats	Watchdog resets and other information
0x1C (28)	CAN Transceiver Statistics	x1C_Resp_CAN_Trans_Stats	Information on the CAN transceiver
0x20 (32)	Clear latched wake flags	x20_Cmd_Clear_Latch_Wake_Flags	Clear any latched wake flags
0x21 (33)	Clear latched wake flags command received	x21_Resp_Clear_Latch_Wake_Flags	Confirms that latched flag clear command has been received
0x30 (48)	Get the Gas sensor update rate	x30_Cmd_Get_Gas_Update_ms	Get Gas sensor update rate
0x31 (49)	Set gas sensor update rate	x31_Cmd_Set_Gas_Update_ms	Set Gas sensor update rate
0x32 (50)	The current update rate	x32_Resp_Gas_Update_ms	The gas sensor current update rate
0x33 (51)	Get the Water and Temperature sensor update rate	x33_Cmd_Get_W_and_T_Update_ms	Get Water and Temperature sensor update rate
0x34 (52)	Set Water and Temperature sensor update rate	x34_Cmd_Set_W_and_T_Update_ms	Set Water and Temperature sensor update rate
0x35 (53)	The current update rate	x35_Resp_W_and_T_Update_ms	The Water and Temperature sensor current update rate
0x36 (54)	Get the Pressure sensor update rate	x36_Cmd_Get_Pressure_Update_ms	Get Pressure sensor update rate
0x37 (55)	Set Pressure sensor update rate	x37_Cmd_Set_Pressure_Update_ms	Set Pressure sensor update rate
0x38 (56)	The current update rate	x38_Resp_Pressure_Update_ms	The Pressure sensor current update rate
0x3C (60)	Get if the Gas message is on or off	x3C_Cmd_Get_Gas_Msg_On	Get if the CAN message is sent or not
0x3D (61)	Set if the Gas message is on or off	x3D_Cmd_Set_Gas_Msg_On	Set if the CAN message is sent or not
0x3E (62)	Gas message is on or off unit response	x3E_Resp_Gas_Msg_On	Response if the CAN message is sent or not
0x3F (63)	Get if the Water and Temperature message is on or off	x3F_Cmd_Get_W_and_T_Msg_On	Get if the CAN message is sent or not
0x40 (64)	Set if the Water and Temperature message is on or off	x40_Cmd_Set_W_and_T_Msg_On	Set if the CAN message is sent or not
0x41 (65)	Water and Temperature message is on or off unit response	x41_Resp_W_and_T_Msg_On	Response if the CAN message is sent or not
0x42 (66)	Get if the Pressure message is on or off	x42_Cmd_Get_Pressure_Msg_On	Get if the CAN message is sent or not
0x43 (67)	Set if the Pressure message is on or off	x43_Cmd_Set_Pressure_Msg_On	Set if the CAN message is sent or not

Hex (Decimal) Value	Purpose	CAN DBC Name	Description
0x44 (68)	Pressure message is on or off unit response	x44_Resp_Pressure_Msg_On	Response if the CAN message is sent or not
0x49 (73)	Get Pressure Wake settings	x49_Cmd_Get_Pressure_Wake	Get Pressure Wake settings
0x4A (74)	Set Pressure Wake Settings	x4A_Cmd_Set_Pressure_Wake	Set Pressure Wake Settings
0x4B (75)	Unit's response containing pressure Wake settings	x4B_Resp_Pressure_Wake	Unit's response containing pressure Wake settings
0x52 (82)	Get Relative Humidity Wake settings	x52_Cmd_Get_RH_Wake	Get Relative Humidity Wake settings
0x53 (83)	Set Relative Humidity Wake Settings	x53_Cmd_Set_RH_Wake	Set Relative Humidity Wake Settings
0x54 (84)	Unit's response containing Relative Humidity Wake settings	x54_Resp_RH_Wake	Unit's response containing Relative Humidity Wake settings
0x55 (85)	Get Dew Point Wake settings	x55_Cmd_Get_Dew_Point_Wake	Get Dew Point Wake settings
0x56 (86)	Set Dew Point Wake Settings	x56_Cmd_Set_Dew_Point_Wake	Set Dew Point Wake Settings
0x57 (87)	Unit's response containing Dew Point Wake settings	x57_Resp_Dew_Point_Wake	Unit's response containing Dew Point Wake settings
0x58 (88)	Get Air Temperature Wake settings	x58_Cmd_Get_Air_Temp_Wake	Get Air Temperature Wake settings
0x59 (89)	Set Air Temperature Wake Settings	x59_Cmd_Set_Air_Temp_Wake	Set Air Temperature Wake Settings
0x5A (90)	Unit's response containing Air Temperature Wake settings	x5A_Resp_Air_Temp_Wake	Unit's response containing Air Temperature Wake settings
0x68 (104)	Get the accelerometers update rate in milliseconds	x68_Cmd_Get_Accel_Update_ms	Get the accelerometers update rate in milliseconds
0x69 (105)	Set the accelerometers update rate in milliseconds	x69_Cmd_Set_Accel_Update_ms	Set the accelerometers update rate in milliseconds
0x6A (106)	Unit's response containing accelerometer update rate	x6A_Resp_Accel_Update_ms	Unit's response containing accelerometer update rate
0x6B (107)	Accelerometer message is on or off info	x6B_Cmd_Get_Accel_Msg_On	Accelerometer message is on or off info
0x6C (108)	Set accelerometer message on or off	x6C_Cmd_Set_Accel_Msg_On	Set accelerometer message on or off
0x6D (109)	Unit's response detailing if accelerometer message is on or off	x6D_Resp_Accel_Msg_On	Unit's response detailing if accelerometer message is on or off
0x6E (110)	Accelerometer Wakes info	x6E_Cmd_Get_Accel_Wake	Accelerometer Wakes info
0x6F (111)	Set accelerometer Wakes	x6F_Cmd_Set_Accel_Wake	Set accelerometer Wakes
0x70 (112)	Units response detailing accelerometer Wake settings	x70_Resp_Accel_Wake	Units response detailing accelerometer Wake settings
0x71 (113)	Get the update rate of the gas sensor for H2	x71_Cmd_Get_H2_Update_ms	Get the update rate of the gas sensor for H2
0x72 (114)	Set the update rate of the gas sensor for H2	x72_Cmd_Set_H2_Update_ms	Set the update rate of the gas sensor for H2
0x73 (115)	The update rate of the H2 sensor	x73_Resp_H2_Update_ms	The update rate of the H2 sensor
0x74 (116)	Get if the H2 sensor message is transmitted	x74_Cmd_Get_H2_Msg_On	Get if the H2 sensor message is transmitted

Hex (Decimal) Value	Purpose	CAN DBC Name	Description
0x75 (117)	Set if the H2 sensor message is transmitted	x75_Cmd_Set_H2_Msg_On	Set if the H2 sensor message is transmitted
0x76 (118)	If the H2 sensor message is on or off	x76_Resp_H2_Msg_On	If the H2 sensor message is on or off
0x77 (119)	Get the current gas H2 baseline %	x77_Cmd_Get_H2_Baseline	Get the current gas H2 baseline %
0x78 (120)	Set the gas H2 baseline as the value specified by the user	x78_Cmd_Set_User_H2_Baseline	Set the gas H2 baseline as the value specified by the user
0x79 (121)	Set the gas H2 baseline value as the current H2 value	x79_Cmd_Set_Curr_H2_Baseline	Set the gas H2 baseline value as the current H2 value
0x7A (122)	The units H2 gas baseline value	x7A_Resp_H2_Baseline	The units H2 gas baseline value
0x7B (123)	Sets the H2 Wake settings	x7B_Cmd_Get_H2_Wake	Sets the H2 Wake settings
0x7C (124)	The H2 Wake settings	x7D_Resp_H2_Wake	The H2 Wake settings

TABLE 8 CONFIGURATION MESSAGE TYPES

[1] If the value has been reconfigured but not saved the unit will send the reconfigured value.

[2] Rows in blue are only applicable to the product number A1.

\*Gas wake features not applicable to the product number V2.

# Heartbeat – HG\_Config Multiplexor x00\_Heartbeat

## Overview

This CAN message is used to output the unit's high-level status including Wake flags and errors

## Default settings

- CAN Start Address + 0 = (0x30A by default)
- Message Multiplexor value: 0x0
- Output rate is set to 1000ms

## Format

- Intel
- 8 bytes in length

## Layout

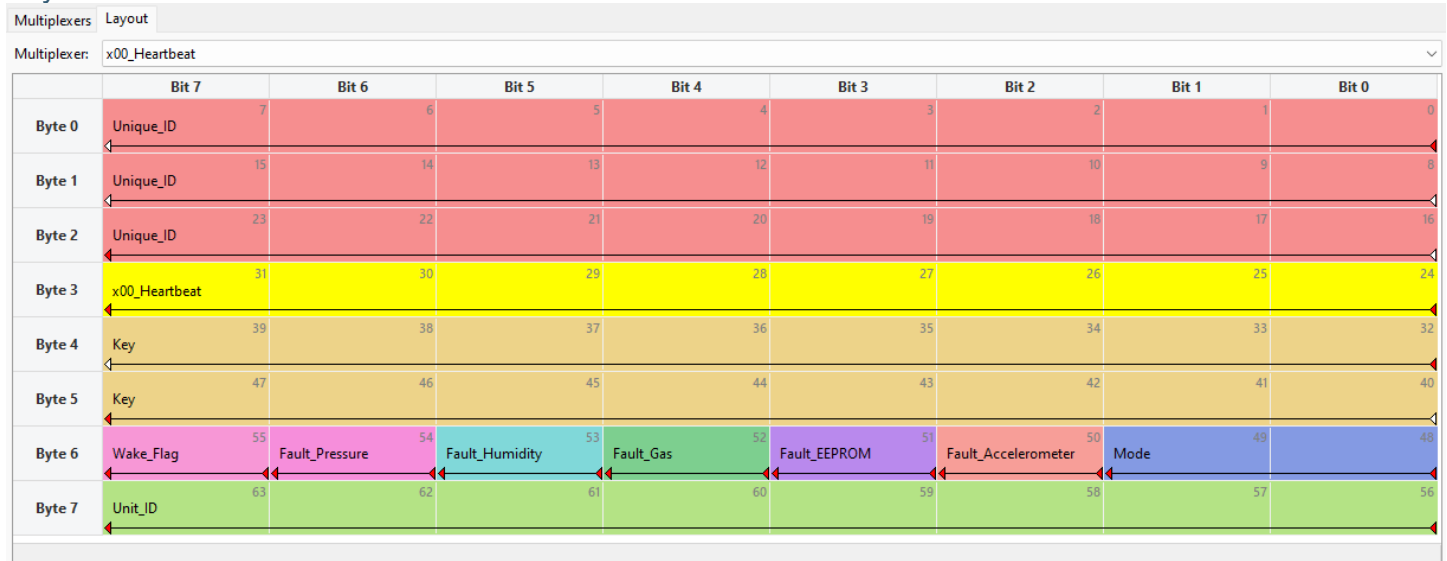

Byte(s)	Data Type	Name	Description
0 – 2	Unsigned 24 bit	Unique_ID	The unit's unique ID code, this cannot be changed
3	Enumeration	Multiplexor	The multiplexor value, for this message, Heartbeat it is 0x0, please see Table 8 Configuration Message Types for possible values
4 – 5	Unsigned 16 bit	Key	The key code required to enter setup or save any settings, this key changes please use the current stated key.
6 – bit 0-1	Enumeration	Mode	The unit's mode: <ol style="list-style-type: none"> <li>1. Normal</li> <li>2. Setup</li> <li>3. Silent – CAN is turned off and unit will wake if commanded to, power cycled or a threshold is detected</li> </ol>
6 – bit 2	Bit	Fault_Accelerometer	Fault detected with Accelerometer
6 – bit 3	Bit	Fault_EEPROM	Fault detected with EEPROM
6 – bit 4	Bit	Fault_Gas	Fault detected with H2 sensor
6 – bit 5	Bit	Fault_Humidity	Fault detected with Humidity sensor
6 – bit 6	Bit	Fault_Pressure	Fault detected with Pressure sensor
6 – bit 7	Bit	Wake_Flag	One of the Wake flags have been set
7	Unsigned 8 bit	Unit_ID	A user configurable ID to identify multiple units if they are on the same CAN bus

TABLE 9 HEART BEAT CAN MESSAGE

## User Manual

### Enter Setup Command (0x01\_Cmd\_Enter\_Setup)

Mux Value Hex (Decimal): 0x01 (1)

Type: Sent to unit

Frequency: NA

Description: No configuration options can be changed until the unit is in setup mode. Sending this command with the correct key value will put the unit into setup mode.

Layout:

Byte(s)	Data Type	Name	Description
0 – 2	Unsigned 24 bit integer	Unique ID	Unique ID
3	Unsigned 8 bit integer	Message Type	<b>0x01</b> – Enter setup command
4-5	Unsigned 16 bit integer	Key	The value in this field <b>must</b> be the same as the Key value in the heartbeat message for the command to be accepted. The key value will change each time a correct one has been received.

### Save Setup Command (0x02\_Cmd\_Save\_Setup)

Mux Value Hex (Decimal): 0x02 (2)

Type: Sent to unit

Frequency: NA

Description: Sending this message with the correct key value in the key field will save any configuration changes that have been made during setup mode.

Layout:

Byte(s)	Data Type	Name	Description
0 – 2	Unsigned 24 bit integer	Unique ID	Unique ID
3	Unsigned 8 bit integer	Message Type	<b>0x02</b> – Save setup command
4-5	Unsigned 16 bit integer	Key	The value in this field <b>must</b> be the same as the Key value in the heartbeat message for the command to be accepted. The key value will change each time a correct one has been received.

### Cancel Setup Command (0x03\_Cmd\_Cancel\_Setup)

Mux Value Hex (Decimal): 0x03 (3)

Type: Sent to unit

Frequency: NA

Description: Sending this message will exit the current setup mode and any changes will **not** be saved.

Layout:

Byte(s)	Data Type	Name	Description
0 – 2	Unsigned 24 bit integer	Unique ID	Unique ID
3	Unsigned 8 bit integer	Message Type	<b>0x03</b> – Cancel setup command

## User Manual

### Reset Unit To Factory Default Settings (0x04\_Cmd\_Rst\_to\_Factory\_Defaults)

Mux Value Hex (Decimal): 0x04 (4)

Type: Sent to unit

Frequency: NA

Description: Sending this message and a valid Key will reset the unit to factory default settings. The unit does not need to be in setup mode for this to work.

Layout:

Byte(s)	Data Type	Name	Description
0 – 2	Unsigned 24 bit integer	Unique ID	Unique ID
3	Unsigned 8 bit integer	Message Type	<b>0x04</b> – Restore to Factory Defaults command
4-5	Unsigned 16 bit integer	Key	The value in this field must be the same as the Key value in the heartbeat message for the command to be accepted. The key value will change each time a correct one has been received.

### Reboot Device (0x05\_Cmd\_Reboot\_Device)

Mux Value Hex (Decimal): 0x05 (5)

Type: Sent to unit

Frequency: NA

Description: Sending this message and a valid Key will reboot the device. The unit does not need to be in setup mode for this to work.

Layout:

Byte(s)	Data Type	Name	Description
0 – 2	Unsigned 24 bit integer	Unique ID	Unique ID
3	Unsigned 8 bit integer	Message Type	<b>0x05</b> – Reboot device command
4-5	Unsigned 16 bit integer	Key	The value in this field must be the same as the Key value in the heartbeat message for the command to be accepted. The key value will change each time a correct one has been received.

### Get Unit Information and Errors (0x06\_Cmd\_Get\_Info\_and\_Errors)

Mux Value Hex (Decimal): 0x06 (6)

Type: Sent to unit

Frequency: NA

Description: This message only works if the unit is in setup mode. If this CAN message is sent, the unit will respond with the following multiplexor messages at the Heartbeat message address:

- 0x17\_Resp\_Firmware\_Version'
- 0x18\_Resp\_Pwr\_Cycle\_Cnt
- 0x1A\_Resp\_EEPROM\_Write\_Cnt
- 0x1B\_Resp\_MCU\_Stats
- 0x1C\_Resp\_CAN\_Tran\_Stats

Layout:

Byte(s)	Data Type	Name	Description
0 – 2	Unsigned 24 bit integer	Unique ID	Unique ID
3	Unsigned 8 bit integer	Message Type	<b>0x06</b> – Get units software version

## User Manual

### Reset Unit Information and Errors (0x07\_Cmd\_Rst\_Info\_and\_Errors)

Mux Value Hex (Decimal): 0x07 (7)

Type: Sent to unit

Frequency: NA

Description: This message only works if the unit is in setup mode. If this CAN message is sent, the unit will reset error counters (the units power cycle and EEPROM write count will not be reset).

Layout:

Byte(s)	Data Type	Name	Description
0 – 2	Unsigned 24 bit integer	Unique ID	Unique ID
3	Unsigned 8 bit integer	Message Type	<b>0x07</b> – Reset units Information and Errors

### Get Unit ID (0x08\_Cmd\_Get\_Unit\_ID)

Mux Value Hex (Decimal): 0x08 (8)

Type: Sent to unit

Frequency: NA

Description: This message only works if the unit is in setup mode. If this CAN message is sent, the unit will respond with the configured unit ID that is part of the heartbeat message.

Layout:

Byte(s)	Data Type	Name	Description
0 – 2	Unsigned 24 bit integer	Unique ID	Unique ID
3	Unsigned 8 bit integer	Message Type	<b>0x08</b> – Get Unit ID

### Set Unit ID (0x09\_Cmd\_Set\_Unit\_ID)

Mux Value Hex (Decimal): 0x09 (9)

Type: Sent to unit

Frequency: NA

Description: This message only works if the unit is in setup mode. If this CAN message is sent, the unit will respond with the configured unit ID that is part of the heartbeat message.

Layout:

Byte(s)	Data Type	Name	Description
0 – 2	Unsigned 24 bit integer	Unique ID	Unique ID
3	Unsigned 8 bit integer	Message Type	<b>0x09</b> – Set Unit ID
4	Unsigned 8 bit integer	Unit ID	The value that the unit ID field should show in the heartbeat message will accept a value of 0 -255

## User Manual

### Received Unit ID (0x0A\_Resp\_Unit\_ID)

Mux Value Hex (Decimal): 0x0A (10)

Type: Transmitted from unit

Frequency: NA

Description: This is the response message from the sensor giving the current Unit ID that is in the heartbeat message.

Layout:

Byte(s)	Data Type	Name	Description
0 – 2	Unsigned 24 bit integer	Unique ID	Unique ID
3	Unsigned 8 bit integer	Message Type	<b>0x0A</b> - Received Unit ID
4	Unsigned 8 bit integer	Unit ID	The value that the unit ID field is (0-255)

### Get CAN Bus Speed (0x0B\_Cmd\_Get\_CAN\_Bus\_Speed)

Mux Value Hex (Decimal): 0x0B (11)

Type: Sent to unit

Frequency: NA

Description: This message only works if the unit is in setup mode. If this CAN message is sent, the unit will respond with the configured CAN bus speed.

Layout:

Byte(s)	Data Type	Name	Description
0 – 2	Unsigned 24 bit integer	Unique ID	Unique ID
3	Unsigned 8 bit integer	Message Type	<b>0x0B</b> – Get CAN bus speed command

### Set CAN Bus Speed (0x0C\_Cmd\_Set\_CAN\_Bus\_Speed)

Mux Value Hex (Decimal): 0x0C (12)

Type: Sent to unit

Frequency: NA

Description: This message only works if the unit is in setup mode. This will set the CAN bus speed.

Layout:

Byte(s)	Data Type	Name	Description
0 – 2	Unsigned 24 bit integer	Unique ID	Unique ID
3	Unsigned 8 bit integer	Message Type	<b>0x0C</b> – Set CAN bus speed command
4	Unsigned 8 bit integer	CAN bus speed	The below values in this field correspond to the following CAN speeds:  0 = 1000kbps 1 = 500kbps (default) 2 = 250kbps 3 = 125kbps

## User Manual

### Received CAN Bus Speed (0x0D\_Resp\_CAN\_Bus\_Speed)

Mux Value Hex (Decimal): 0x0D (13)

Type: Transmitted from unit

Frequency: NA

Description: This message only works if the unit is in setup mode. This is a unit response to a set or get CAN Bus Speed message.

Layout:

Byte(s)	Data Type	Name	Description
0 – 2	Unsigned 24 bit integer	Unique ID	Unique ID
3	Unsigned 8 bit integer	Message Type	<b>0x0D</b> – CAN bus speed
4	Unsigned 8 bit integer	CAN bus speed	The below values in this field correspond to the following CAN speeds:  0 = 1000kbps 1 = 500kbps (default) 2 = 250kbps 3 = 125kbps

### Get CAN start address (0x0E\_Cmd\_Get\_CAN\_Start\_Address)

Mux Value Hex (Decimal): 0x0E (14)

Type: Sent to unit

Frequency: NA

Description: This message only works if the unit is in setup mode. If this CAN message is sent, the unit will respond with the configured CAN start address. The start address is the Configuration CAN address, any CAN messages specific to the unit's functions will be sent consecutively after this address.

Layout:

Byte(s)	Data Type	Name	Description
0 – 2	Unsigned 24 bit integer	Unique ID	Unique ID
3	Unsigned 8 bit integer	Message Type	<b>0x0E</b> – get CAN start address

### Set CAN start address (0x0F\_Cmd\_Set\_CAN\_Start\_Address)

Mux Value Hex (Decimal): 0x0F (15)

Type: Sent to unit

Frequency: NA

Description: This message only works if the unit is in setup mode. If this CAN message is sent, the unit it will set the new CAN start address and respond with the configured CAN start address. The start address is the Configuration CAN address, any CAN messages specific to the units function's will be sent consecutively after this address.

Layout:

Byte(s)	Data Type	Name	Description
0 – 2	Unsigned 24 bit integer	Unique ID	Unique ID
3	Unsigned 8 bit integer	Message Type	<b>0x0F</b> – set CAN start address
4 - 5	Unsigned 11 bit integer	CAN address	A value between 0x000 (0) to 0x7FF (2047), this is the theoretical maximum start address, but this will actually be determined by the number of CAN addresses used up by the unit. Maximum start address = 2047 – number of CAN addresses used.

## User Manual

### Received CAN Start Address (0x10\_Resp\_CAN\_Start\_Address)

Mux Value Hex (Decimal): 0x10 (16)

Type: Transmitted from unit

Frequency: NA

Description: This is a unit's response to a set or get CAN Bus start address message.

Layout:

Byte(s)	Data Type	Name	Description
0 – 2	Unsigned 24 bit integer	Unique ID	Unique ID
3	Unsigned 8 bit integer	Message Type	<b>0x10</b> – CAN start address
4 – 5	Unsigned 11 bit integer	CAN address	A value between 0x000 (0) to 0x7FF (2047), this is the theoretical maximum start address, but this will actually be determined by the number of CAN addresses used up by the unit. Maximum start address = 2047 – number of CAN addresses used.

### Get Unit Mode (0x11\_Cmd\_Get\_Sleep\_Mode)

Mux Value Hex (Decimal): 0x11 (17)

Type: Sent to unit

Frequency: NA

Description: This message only works if the unit is in setup mode. If this CAN message is sent, the unit will respond with the configured sleep mode.

Layout:

Byte(s)	Data Type	Name	Description
0 – 2	Unsigned 24 bit integer	Unique ID	Unique ID
3	Unsigned 8 bit integer	Message Type	<b>0x11</b> – Get unit mode command

### Set Unit Mode (0x12\_Cmd\_Set\_Unit\_Mode)

Mux Value Hex (Decimal): 0x12 (18)

Type: Sent to unit

Frequency: NA

Description: This message configures the unit mode. The unit does not need to be in setup mode for this command to work.

Layout:

Byte(s)	Data Type	Name	Description
0 – 2	Unsigned 24 bit integer	Unique ID	Unique ID
3	Unsigned 8 bit integer	Message Type	<b>0x12</b> – Set unit mode command
4-5	Unsigned 16 bit integer	Key	The current key from the heartbeat message
6	Unsigned 8 bit integer	Unit Mode	The below values in this field correspond to the following unit modes:  0 = Normal 1 = Low power (No CAN traffic until Wake threshold is reached or this CAN command is sent to put it back to Normal mode)

## User Manual

### Sleep Mode Response (0x13\_Resp\_Sleep\_Mode)

Mux Value Hex (Decimal): 0x13 (19)

Type: Transmitted from unit

Frequency: NA

Description: This is a unit's response to a set or get unit mode message.

Layout:

Byte(s)	Data Type	Name	Description
0 – 2	Unsigned 24 bit integer	Unique ID	Unique ID
3	Unsigned 8 bit integer	Message Type	<b>0x13</b> – Unit mode response message
4	Unsigned 8 bit integer	Sleep Mode	The below values in this field correspond to the following sleep modes:  0 = Normal 1 = Low power (No CAN traffic until Wake threshold is reached or CAN command is sent to put it back to Normal mode)

### Other Configuration CAN Messages

Please refer to the CAN dbc for more information.

# HG\_H2 (0x30B [default]) – Hydrogen

## Overview

This CAN message is used to output the unit's gas measurement values of Hydrogen (H<sub>2</sub>) in % by volume, the sensor temperature, error codes and Wake flags.

## Default settings

- CAN Start Address + 1 = (0x30B by default)
- Output rate is set to 1000ms

## Format

- Intel
- 8 bytes in length

## Layout

	Bit 7	Bit 6	Bit 5	Bit 4	Bit 3	Bit 2	Bit 1	Bit 0	
Byte 0	H2_Internal_Temp_DegC <sup>7</sup>		6	5	4	3	2	1	0
Byte 1	H2_Internal_Temp_DegC <sup>15</sup>		14	13	12	11	10	9	8
Byte 2	H2_Calculated_Perc_Vol <sup>23</sup>		22	21	20	19	18	17	16
Byte 3	H2_Calculated_Perc_Vol <sup>31</sup>		30	29	28	27	26	25	24
Byte 4	Fault_Gas_Sensor_Error_Detail <sup>29</sup>		38	37	36	35	34	33	32
Byte 5	Fault_Gas_Sensor_Error_Code <sup>47</sup>		46	45	44	43	42	41	40
Byte 6	H2_Self_Test_Error <sup>55</sup>	H2_VDD_Out_Of_R... <sup>54</sup>	H2_Memory_Error <sup>53</sup>	52	51	Wake_Flag_H2 <sup>50</sup>	49	48	
Byte 7	63	62	H2_Temp_Comp_O... <sup>61</sup>	H2_Self_Test_Error <sup>60</sup>	59	58	57	56	

Byte(s)	Data Type	Name	Description
0 – 1	Signed 16 bit	H2_Internal_Temp_DegC	Sensor internal temperature -163 to +163 Deg C
2 – 3	Unsigned 16 bit	H2_Calculated_Perc_Vol	H2 reading by % volume 0 to 131%
4	Unsigned 8 bit	Fault Gas Sensor Error Detail	0x00 Nonempty Frame Error 0x01 No Data Error 0x02 Buffer Size Error 0x03 Stop Byte Error 0x04 Checksum Error 0x05 Timeout Error 0x06 Rx Command Error 0x07 Rx Address Error 0x08 Serial Write Error 0x09 Wrong Number Bytes Error 0x0A CRC Error 0x0B I2c Address Nack 0x0C I2c Data Nack 0x0D I2c Other Error 0x0E Not Enough Data Error 0x0F Internal Buffer Size Error
5	Unsigned 8 bit	Fault Gas Sensor Error Code	0x00 OK 0x01 Write Error 0x02 Read Error 0x03 Tx Frame Error 0x04 Rx Frame Error 0x05 Execution Error 0x80 Sensor Specific Error
6 – bit 2	bit	Wake_Flag_H2	1 if a configured threshold is reached
6 – bit 4-5	2 bit	H2_Memory_Error	1 if sensor memory error
6 – bit 6	bit	H2_VDD_Out_Of_Range	1 if supply voltage is out of range for the sensor
6 – bit 7 to Byte 7 bit 4	6 bit	H2_Self_Test_Error	1 if self-test fail
7 - but	1 bit	H2_Temp_Comp_Out_Of_Range	1 if sensor is beyond calibrated ranges

TABLE 10 HYDROGEN GAS CAN MESSAGE

# HG\_Moisture\_and\_Temp (0x30C [default])

## Overview

This CAN message is used to output the unit's air water content and air temperature information.

## Default settings

- CAN Start Address + 2 = (0x30C by default)
- Output rate is 100ms

## Format

- Intel
- 8 bytes in length

## Layout

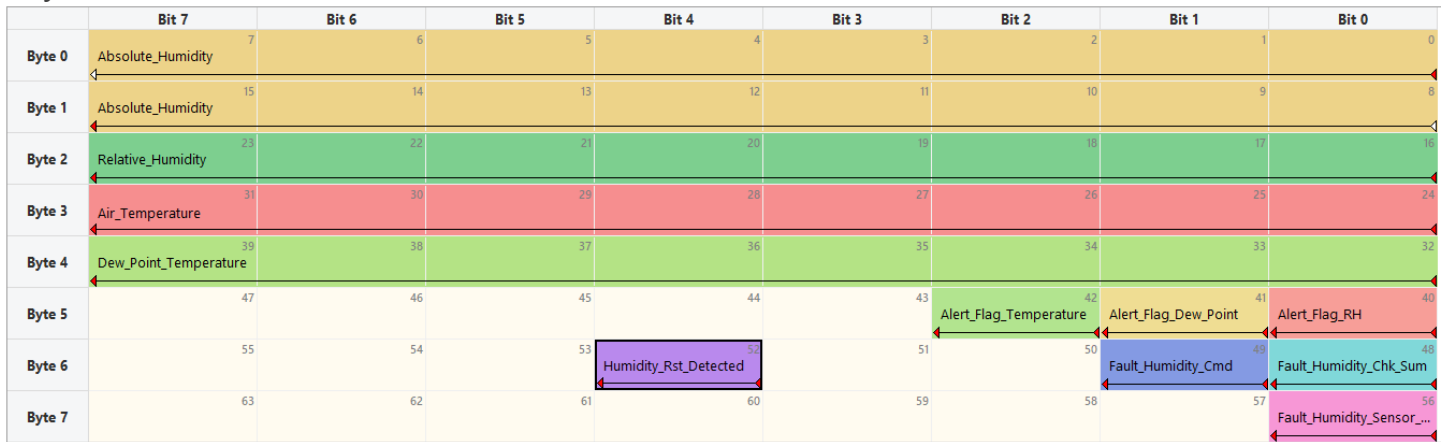

Byte(s)	Data Type	Name	Description
0 – 1	Unsigned16 bit	AbsoluteHumidity	Absolute humidity Measured from 0 – 65535 mg/m <sup>3</sup>
2	Decimal 8 bit	RelativeHumidity	Relative humidity 0 to 100%
3	Decimal 8 bit	AirTemperature	Air temperature -40 to 150 Deg C
4	Decimal 8 bit	DewPointTemperature	Dew point temperature - -0 to 127.5 Deg C (Temperature of object onto which condensation will start forming at)
5 – bit 0	bit	Wake_Flag_RH	Wake flag for Relative Humidity threshold detection
5 – bit 1	bit	Wake_Flag_Dew_Point	Wake flag for Dew Point threshold detection
5 – bit 2	bit	Wake_Flag_Temperature	Wake flag for Air Temperature threshold detection
6 – bit 1	bit	Fault_Humidity_Chk_Sum	Checksum error on read from humidity sensor
6 – bit 2	bit	Fault_Humidity_Cmd	Command message error to humidity sensor
6 – bit 4	bit	Humidity_Rst_Detected	The humidity sensor reset itself
7 – bit 0	bit	Fault_Humidity_Sensor_Comms	Fault with communication to Humidity sensor

TABLE 11 HUMIDITY AND AIR TEMPERATURE CAN MESSAGE

## HG\_Pressure (0x30D [default])

### Overview

This CAN message is used to output the unit's absolute pressure reading in millibar, it is extremely sensitive between 300mbar and 1200mbar.

### Default settings

- CAN Start Address + 3 = (0x30D by default)
- Output rate is 20ms

### Format

- Intel
- 5 bytes in length

### Layout

	Bit 7	Bit 6	Bit 5	Bit 4	Bit 3	Bit 2	Bit 1	Bit 0
Byte 0	Absolute_Pressure 7							
Byte 1	Absolute_Pressure 15							
Byte 2	Absolute_Pressure 23							
Byte 3	Absolute_Pressure 31							
Byte 4						Wake_Flag_Pressure 34	Fault_Pressure_Last_Up... 33	Fault_Pressure_Sensor... 32
Byte 5								
Byte 6								
Byte 7								

Byte(s)	Data Type	Name	Description
0 – 3	Unsigned 32 bit	Absolute_Pressure	Measures from 300mbar to 1200 mbar
4 – bit 0	bit	Fault_Pressure_Sensor	Pressure sensor fault detected
4 – bit 1	bit	Fault_Pressure_Last_Update	Error with reading pressure sensor
4 – bit 2	bit	Wake_Pressure_Flag	Wake flag for pressure threshold detection

TABLE 12 PRESSURE CAN MESSAGE

# HG\_Accelerometer (0x30F [default])

## Overview

This CAN message is used to output the unit's acceleration reading in g as well as flag any Wakes due to over g and/or sensor errors.

## Default settings

- CAN Start Address + 5 = (0x30F by default)
- Output rate is 10ms

## Format

- Intel
- 8 bytes in length

## Layout



Byte(s)	Data Type	Name	Description
0 – 2	Signed 16 bit	Xg	Acceleration in X axis +-24g
3 – 4	Signed 16 bit	Yg	Acceleration in Y axis +-24g
5 – 6	Signed 16 bit	Zg	Acceleration in Z axis +-24g
6 – bit 0	bit	Fault_Accelerometer_Init	Wake flag for accelerometer initialization fault
6 – bit 1	bit	Fault_Accelerometer_Read	Last accelerometer read was unsuccessful
6 – bit 2	bit	Fault_Accelerometer_Self_Test	Accelerometer failed its self-test
7 – bit 0	bit	Xg_Under_g_Wrn	X axis under g threshold warning
7 – bit 1	bit	Xg_Over_g_Wrn	X axis over g threshold warning
7 – bit 2	bit	Yg_Under_g_Wrn	Y axis under g threshold warning
7 – bit 3	bit	Yg_Over_g_Wrn	Y axis over g threshold warning
7 – bit 4	bit	Zg_Under_g_Wrn	Z axis under g threshold warning
7 – bit 5	bit	Zg_Over_g_Wrn	Z axis over g threshold warning
7 – bit 7	bit	Wake_Accelerometer	True if any of the axis have triggered an Wake

TABLE 13 ACCELEROMETER CAN MESSAGE

## List of Tables

Table 1 Sensor Performance .....	6
Table 2 Environmental Performance .....	6
Table 3 Mechanical Performance .....	7
Table 4 Electrical Performance .....	7
Table 5 Connection Information .....	7
Table 6 CAN Message Output Summary .....	17
Table 7 CAN Configuration Message .....	18
Table 8 Configuration Message Types .....	22
Table 9 Heart Beat CAN Message .....	23
Table 10 Hydrogen Gas CAN Message .....	32
Table 12 Humidity and Air Temperature CAN message .....	33
Table 13 Pressure CAN message .....	34
Table 14 Accelerometer CAN message .....	35

## List of Figures

Figure 1 Mating Connector - Pin 1 is Right Hand Side (Top-Down View) .....	8
Figure 2 Connector Crimp Details .....	8
Figure 3 Wiring Example .....	9
Figure 4 Sensor Dimensions .....	10
Figure 5 External Features .....	11
Figure 6 Default CAN Message Output .....	13

# Appendix A – Example CAN Message Workflow to Change a Setting

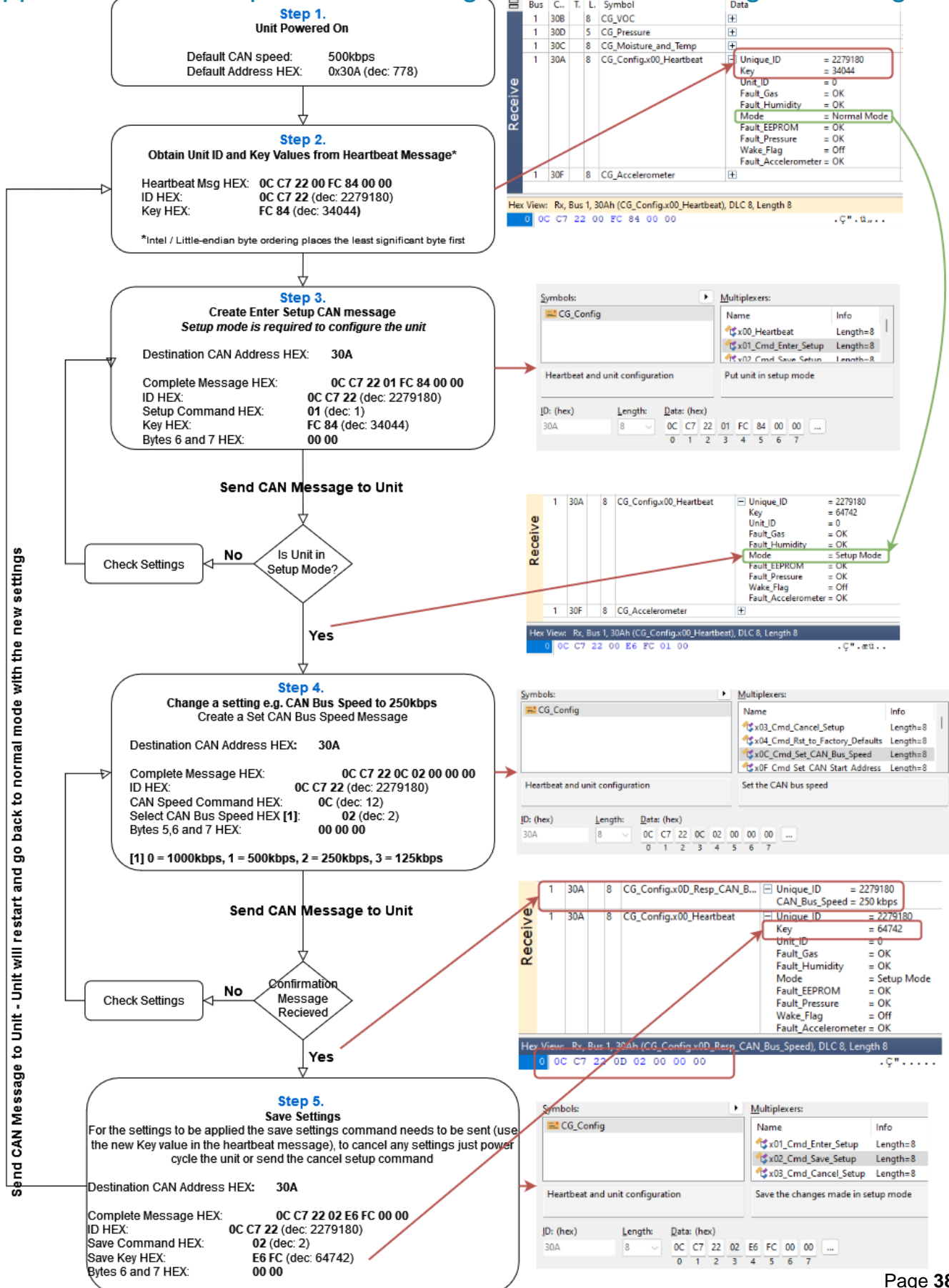

## Appendix B – Example CAN Message to Change Message Update Rate

This example uses the PCAN software tool and a USB to CAN adapter to setup the unit, however it will be similar in any CAN tool/adaptor.

- If the sensor is connected correctly the heartbeat message should be visible every 1Hz (the default CAN speed is 500kbps and the unit is not terminated).

The example heartbeat message below has a raw Hex value of: **6C 15 E4 00 E8 64 00 00**

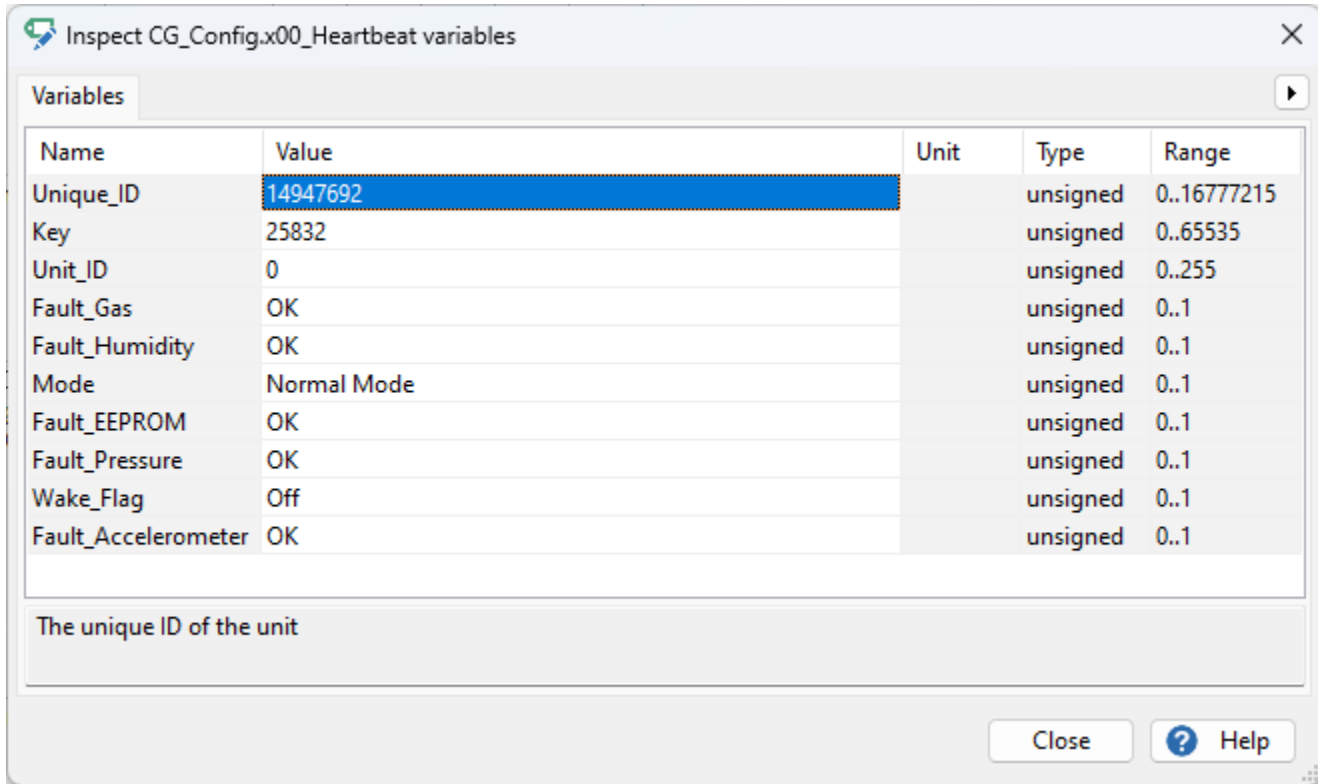

The screenshot shows a window titled "Inspect CG\_Config.x00\_Heartbeat variables". It contains a table with the following data:

Name	Value	Unit	Type	Range
Unique_ID	14947692		unsigned	0..16777215
Key	25832		unsigned	0..65535
Unit_ID	0		unsigned	0..255
Fault_Gas	OK		unsigned	0..1
Fault_Humidity	OK		unsigned	0..1
Mode	Normal Mode		unsigned	0..1
Fault_EEPROM	OK		unsigned	0..1
Fault_Pressure	OK		unsigned	0..1
Wake_Flag	Off		unsigned	0..1
Fault_Accelerometer	OK		unsigned	0..1

Below the table, there is a text field containing "The unique ID of the unit". At the bottom right, there are "Close" and "Help" buttons.

- Create a setup message using the Unique\_ID and Key that are in the heartbeat message and send it to the unit.

The Raw Hex for the setup message is: **6C 15 E4 01 E8 64 00 00**

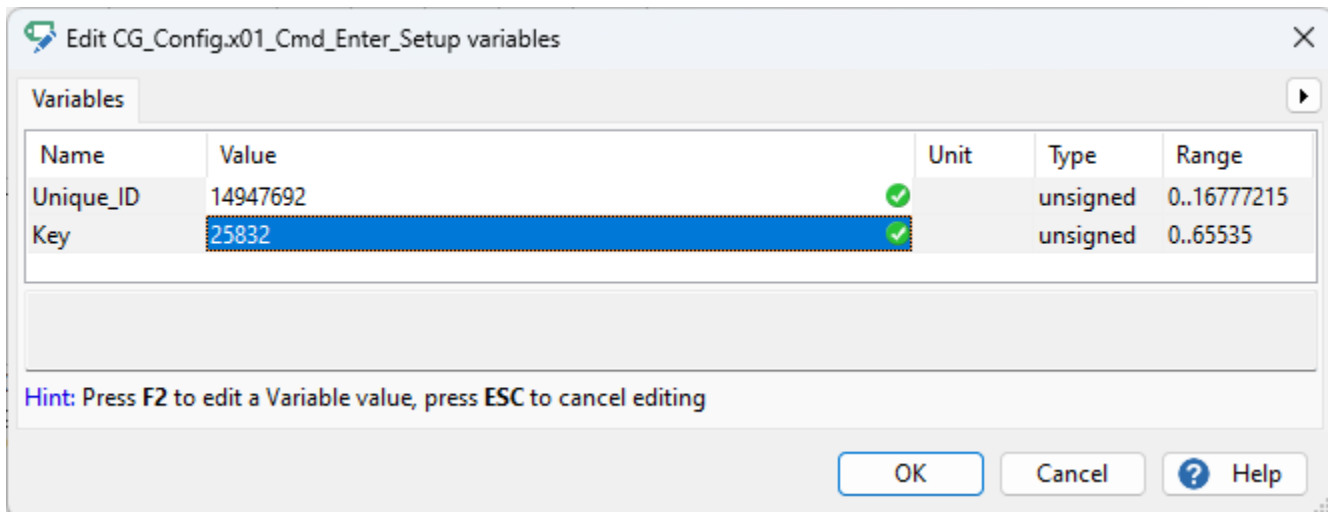

The screenshot shows a window titled "Edit CG\_Config.x01\_Cmd\_Enter\_Setup variables". It contains a table with the following data:

Name	Value	Unit	Type	Range
Unique_ID	14947692	✓	unsigned	0..16777215
Key	25832	✓	unsigned	0..65535

Below the table, there is a hint: "Hint: Press F2 to edit a Variable value, press ESC to cancel editing". At the bottom right, there are "OK", "Cancel", and "Help" buttons.

## User Manual

- Send the previous message and the unit should go into setup mode (this will change the key value as well). The heartbeat raw hex should now look like: **6C 15 E4 01 ?? ?? 01 00** for setup mode (?? ?? Will be the new 2 byte key value you need to save the setup).
- Modify and send x34\_Cmd\_Set\_W\_and\_T\_Update\_ms. In your tool, create a new CAN message with ID 0x30A and 3<sup>rd</sup> multiplexor byte set to 0x34. For 5000ms update rate for temperature the hex for the above message should be: **6C 15 E4 34 88 13** (it is 6 bytes long, not the normal 8).

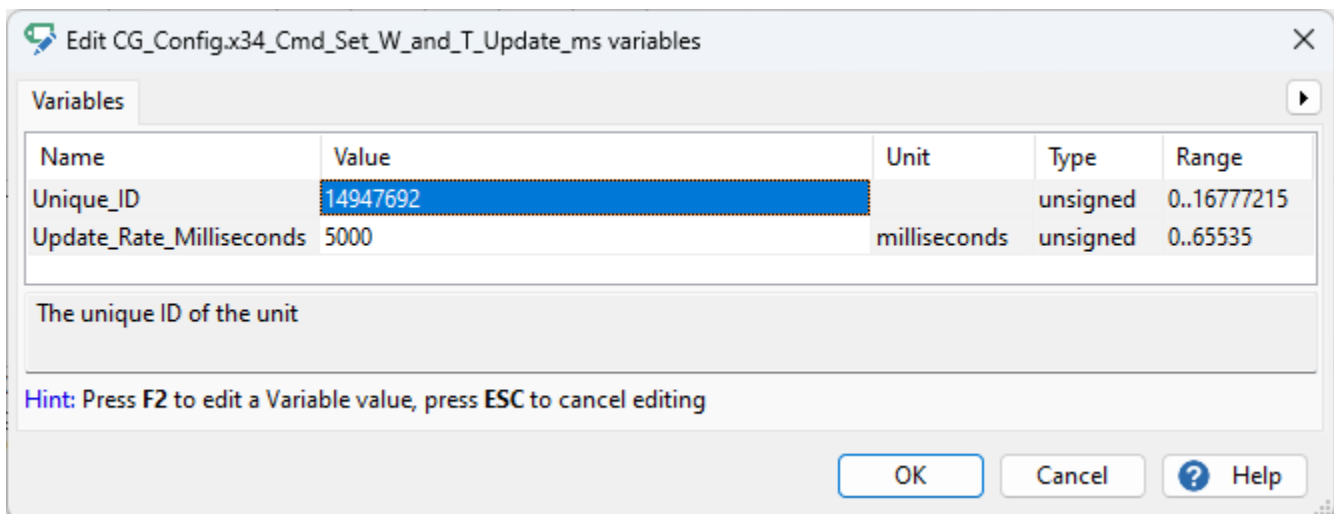
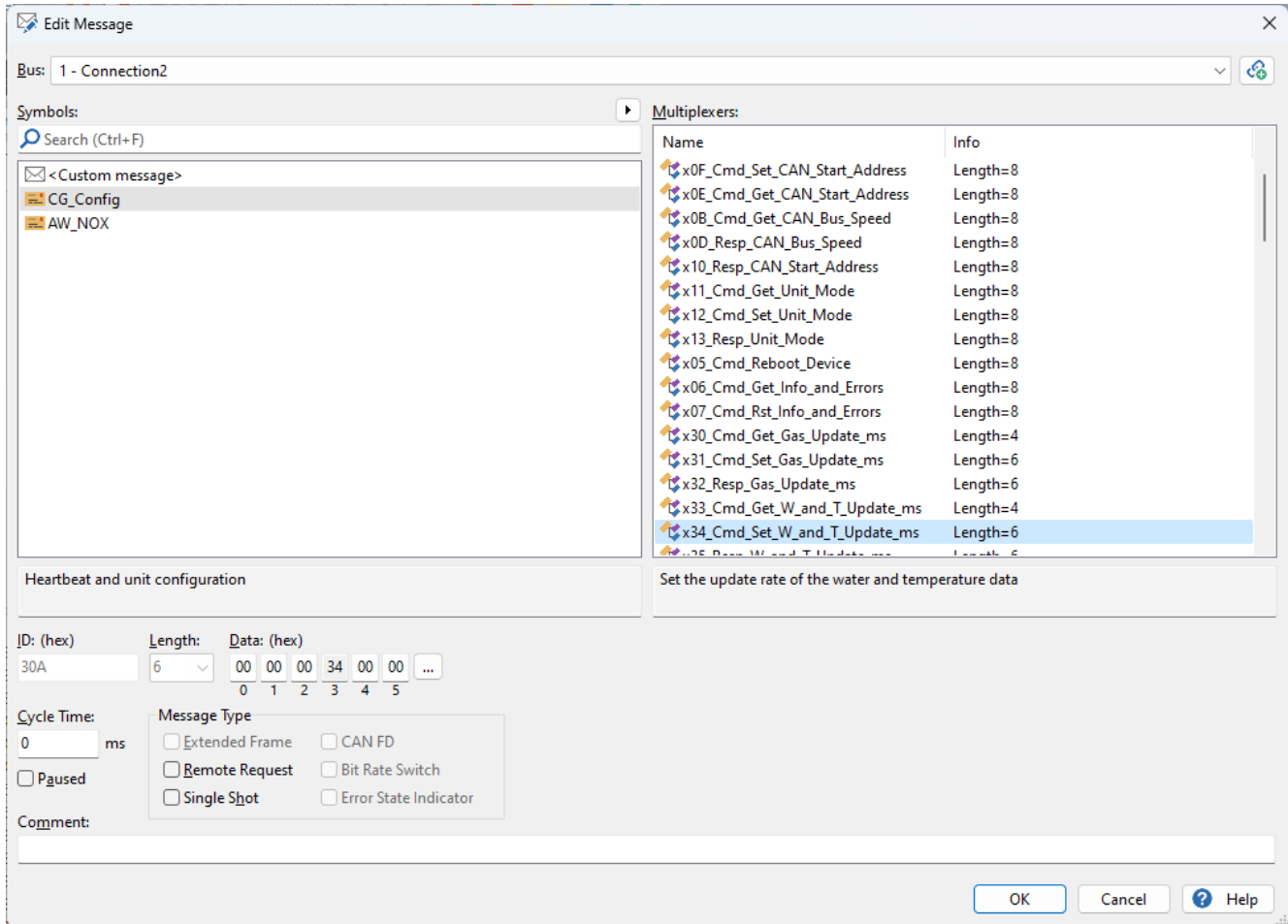

## User Manual

- Send the CAN message x02\_Cmd\_Save\_Setup, to save and exit setup mode. The raw hex in this example is: **0C 6C 15 E4 ?? ?? 00 00** where ?? ?? is the hex of the new key value in the heartbeat message (bytes 4 and 5 in the heartbeat message).

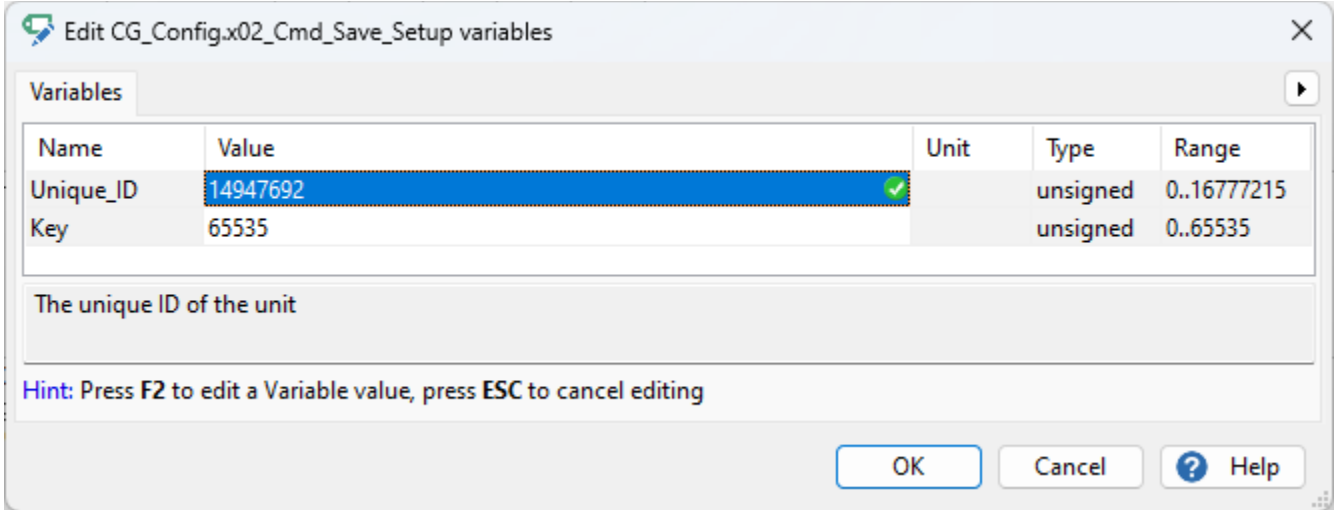

- The update rate for the moisture and temperature CAN message should now be 5000ms.

## Appendix C – Example Functionality Test Method

H Guard comes factory calibrated; however, it is advisable to perform a check before use. In order to cross reference and check parameters such as temperature, humidity and pressure, a laboratory calibrated sensor should be placed in the same environment as H Guard. One recommendation for such a sensor is the [Traceable® Digital Barometer with Calibration - Cole-Parmer \(coleparmer.com\)](#) but others are available.

The Hydrogen sensor is factory calibrated, to check that the Hydrogen sensor is working we recommend using a laboratory calibrated hydrogen air mixture. The sensor will need to be sealed in with this hydrogen air mixture.

For the accelerometer, there is no need to re-calibrate, however we do check that the vector magnitude of the three axes equate to 1G +/- 5%.

End of Document